



BULLSEYE TRX



White's Electronics, Inc.
Sweet Home, Oregon USA

Building the world's finest metal detectors for over 60 years.

Introduction

Congratulations on selecting the White's *Bullseye TRX* pinpointer. The *Bullseye TRX* is unlike any other pinpointer on the market. Using the latest miniaturized components, we've put a complete ground-balancing Very Low Frequency (VLF) circuit inside the *TRX* housing. The *Bullseye TRX* has excellent sensitivity, and "grabs" the ground to detect deeper targets.

The *Bullseye TRX* packs in more features than any other pinpointer. Ratcheting ground grab, proportional response, selectable beeper and/or vibrator, LED light, lanyard loops, dual battery operation, and a weatherproof housing with depth markings make the *Bullseye TRX* the most complete pinpointer on the market.

Batteries

The *Bullseye TRX* can accept either two AA batteries (included) or a single 9V battery.

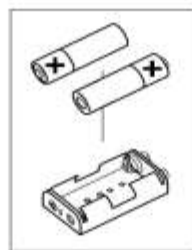

Two AA Batteries

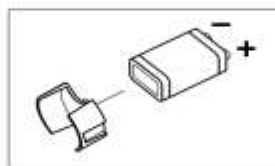
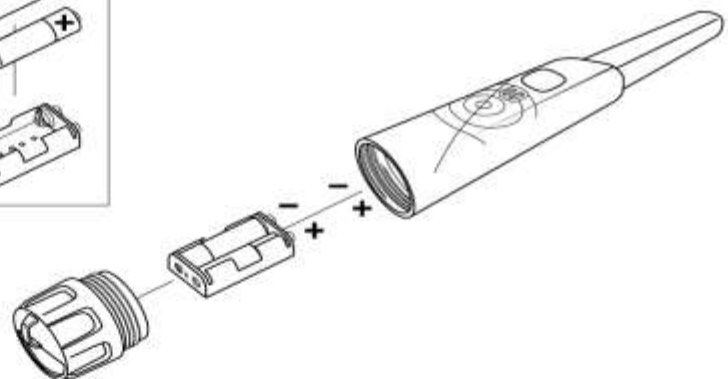

One 9V Battery

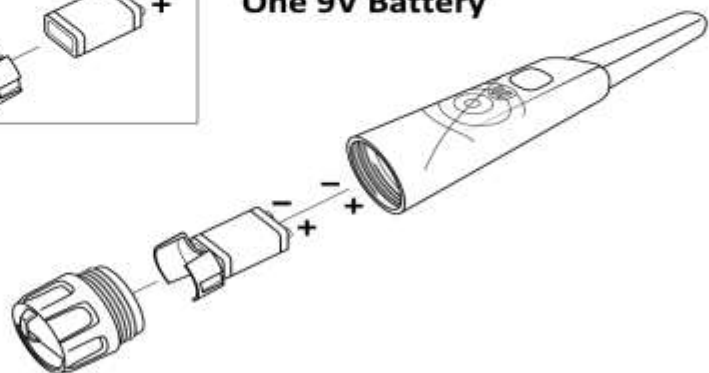

Battery installation is easy and is illustrated at right.

Features

Audio alert — The *Bullseye TRX* produces a repeating beep on target detection. The repetition rate of the beeps increases as the probe gets closer to the target. Most targets within 1/4" of the probe result in a continuous tone. The audio alert can be turned off.

Vibrate alert — A vibrator produces short, repeating vibrations in sync with the audio alert. The vibrator can be turned off or used alone, without the audio alert.

LED light — An LED provides illumination while probing and acts as a power-on indicator.

Ground balance — A quick-press of the button "grabs" the ground reading for accurate ground balance.

Target ratcheting — A quick-press of the button ratchets in on strong target signals.

Overload indicator — An excessively large target will create a series of long responses.

Low battery alert — During power-on, three cycles of a two-tone alarm indicate a low battery. During operation, each button press will create the same alarm if the battery is low. The LED also blinks continuously to indicate a low battery.

Holster — *Bullseye TRX* includes a carry holster, which fits up to a 3-inch wide belt. It also includes a lanyard attachment loop.

Ruler — The *Bullseye TRX* has a ruler imprinted into the housing for determining target depth.

Dual battery operation — The *Bullseye TRX* operates with either two AA batteries or a single 9V battery using the included adapter.

Lost pinpoint alarm — If you leave your *Bullseye TRX* powered on, after five minutes of inactivity it sounds a long beep every 15 seconds to help you relocate it. A quick-press of the button resets the five-minute timer. The bright orange battery cap also helps in finding a lost *Bullseye TRX*.

Automatic power-off — After five minutes, the lost pinpoint alarm ceases and the *Bullseye TRX* powers down with a two-tone beep.

Replaceable shell — Scraping around in the dirt will eventually wear through the plastic of any pinpointer. The *Bullseye TRX* is built to last with an easily replaceable shell that saves you money.

Operation

Power On

1. Hold the unit away from the ground and any metal.
2. Quickly press and release the button. The *Bullseye TRX* will beep once followed by two short beeps indicating that it's ready to use.

Power Off

1. **Press and hold** the button for half a second.
2. When you hear a two-tone beep, release the button. The unit will power down.

Ground/Target Reset

During operation, a *quick press* of the button performs a "grab" function. In the absence of a target, this grabs the ground phase and resets the ground balance. In the presence of a target, it can be used to ratchet in on strong target signals.

Beep or Vibration Selection

The *Bullseye TRX* can indicate target proximity with either an audible beep or a vibration response. Both are "on" by default, but it is recommended that you choose one

or the other to minimize battery drain.

1. Turn the unit on.
2. Press and hold the button for half a second, and listen for the two-tone power-down jingle.
3. **Continue holding down the button.** After two more seconds, the *Bullseye TRX* will enter Setup Mode, signified by a two-tone "boo-beep."
4. **Continue holding down the button.** After another two seconds, the *Bullseye TRX* will begin to cycle through the beeper/vibration selections:
 - Beeper and vibrator
 - Beeper only
 - Vibrator only

Note: the selection always starts with the currently selected mode.

5. When you reach the desired selection, simply release the button and the *Bullseye TRX* will exit setup, indicated by two short beeps.

Changes to this setting are automatically saved when the *TRX* is powered off.

Locating and Digging

When you locate a target with your primary detector, before digging a hole, use the *Bullseye TRX* to scan the surface of the ground. Do this by pointing the unit straight down and moving it around the suspected area. Often the target will be less than 3" deep and can be detected with the *Bullseye TRX*, making recovery easier.

If a surface scan doesn't detect the target, dig an appropriate plug or flap cut in the turf. Use the *Bullseye TRX* to scan both the plug (or flap) and down into the hole. In some

cases, a coin on edge will be difficult to pinpoint and may be in the sidewall of the hole. Be sure to scan the walls of the hole.

Be mindful of proper digging techniques when extracting the target. Use the smallest appropriate digging tool, especially in public areas. Learn to cut plugs that avoid turf damage or, better yet, how to "pop" coins using only a screwdriver. There are numerous videos on *YouTube* that demonstrate good target extraction protocol.

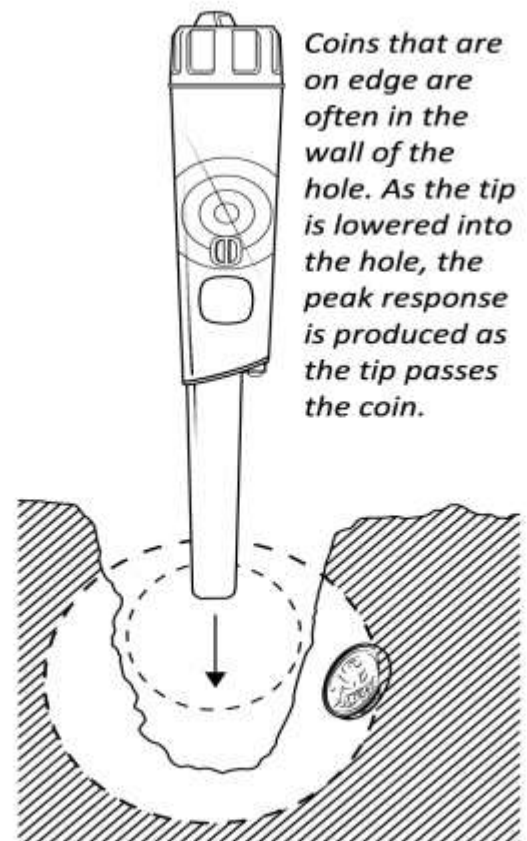
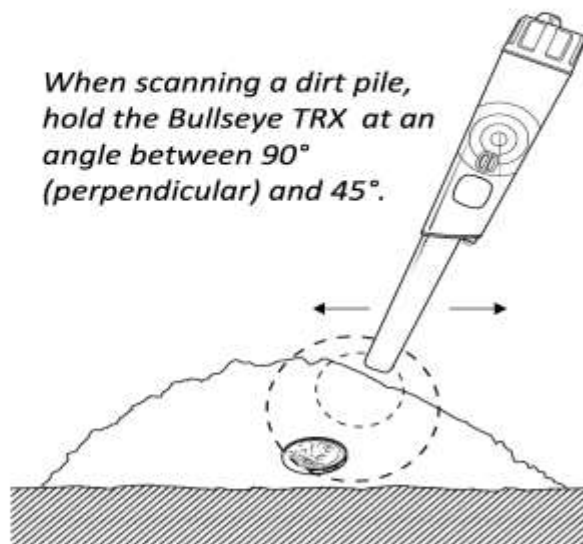
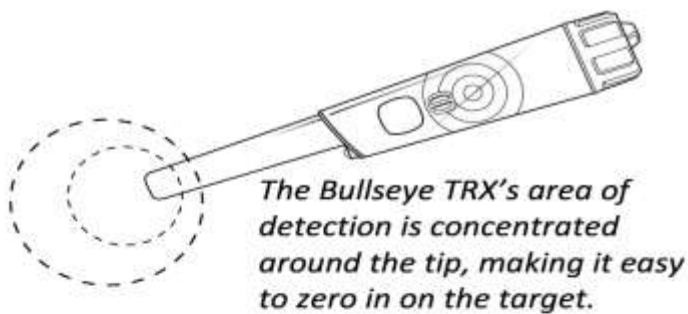

Troubleshooting

Unit won't turn on, turns on but turns off quickly, performs erratically.	Replace the battery. Check that battery is inserted correctly, with proper polarity (positive to positive, negative to negative).
Unit sounds a false alert as it approaches the ground.	Place the tip to the ground but away from metal and quick-press the button to "grab" the ground reading.
Unit turns on and produces a three-tone beep before the two-tone "ready" signal.	Unit is probably overloaded. Make sure it is held away from ground and metal during turn-on.
Target appears to be large and difficult to pinpoint.	Quick-press the button to ratchet down the sensitivity. This reduces the apparent size of strong targets.
Target is detected but then disappears as the probe is moved deeper into the hole.	Target is probably in the sidewall of the hole.

Specifications

Operating mode	VLF-IB
Frequency	12 kHz
Temperature range	5° to 158°F (-15° to +70°C)
Search modes	All Metal non-motion
Ground balance	LockTrac with Grab
Target indication	Beeper, vibrate (selectable)
Target response	Proportional
Search coil	0.3" / 7.6mm coaxial
Housing	Weatherproof
Weight	6.5 oz / 185g (with 2 AA batteries)
Length	10 inches / 25cm
Batteries	(2) AA or (1) 9V, alkaline or better
Battery life	20 hours typical
Warranty	2 years, transferable

Warranty

If within two years (24 months) from the original date of purchase, your White's detector fails due to defects in either material or workmanship, White's will repair or replace, at its option, all necessary parts without charge for parts or labor.

Simply return the complete detector to the dealer where you purchased it or to your nearest Authorized Service Center. The unit must be accompanied by a detailed explanation of the symptoms of the failure and proof of date-of-purchase.

This is a transferable manufacturer warranty, which covers the instrument two years from the original purchase date, regardless of the owner.

Items excluded from the warranty are non-rechargeable batteries, accessories that are not standard equipment, shipping/handling costs outside the continental United States, Special Delivery costs (Air Freight, Next Day, 2nd Day, Packaging Services, etc.) and all shipping/handling costs inside the continental United States 90 days after purchase.

White's registers your purchase only if the Sales Registration Card is filled out and returned to the factory address by your dealer, soon after

original purchase.

The warranty does not cover damage caused by accident, misuse, neglect, alterations, modifications, unauthorized service, or prolonged exposure to corrosive compounds, including salt. Duration of any implied warranty (e.g., merchantability and fitness for a particular purpose) shall not be longer than the stated warranty. Neither the manufacturer nor the retailer shall be liable for any incidental or consequential damages.

Some states, however, do not allow the limitation on the length of implied warranties, or the exclusion of incidental or consequential damages. Therefore, the above limitations may not apply to you. In addition, the stated warranty gives you specific legal rights, and you may have other rights which vary from state to state.

The foregoing is the only warranty provided by White's as the manufacturer of your metal detector. Any extended warranty period beyond two years, which may be provided by a dealer or other third party on your detector, may be without White's authority, involvement and consent, and might not be honored by White's Electronics, Inc.

Quick Start

1. Quick-press the button to turn on.
2. Quick-press the button to “grab” a ground reading or to ratchet in on a strong target.
3. Press and hold the button for half a second to turn off.

Customer Support

Questions concerning your *Bullseye TRX*? You can contact us via internet, phone, or mail:

<http://whiteselectronics.com/support.html>

US

1-800-547-6911

White's Electronics
1011 Pleasant Valley Road
Sweet Home, Oregon 97386

UK

(0044) 1463 223456

White's Electronics
35 Harbour Road
Inverness, Scotland IV1 1UA

This device complies with part 15 of the FCC Rules. Operation is subject to the following two conditions: (1) This device may not cause harmful interference, and (2) this device must accept any interference received, including interference that may cause undesired operation. Changes or modifications not expressly approved by White's Electronics could void the user's authority to operate the equipment.



www.whiteselectronics.com

White's metal detectors are proudly designed, built, and tested in Sweet Home, Oregon USA by the employees of White's Electronics.

Part Number 621-0547 – V1.0